



**REWIRE**  
**SECURITY**



**103-RS / 103-RS+ USER MANUAL**

# Contents

- 1. Introduction..... 4
- 2. Applications..... 4
- 3. Hardware Description..... 5
- 4. Accessories ..... 6
- 5. Specifications..... 7
- 6. Operating Instructions..... 8
  - 6.1 Installation..... 8
  - 6.2 SIM CARD Installation..... 10
  - 6.3 Turn on the 103-RS..... 10
  - 6.4 GSM/GPS LED Indicator ..... 10
  - 6.5 Initialization ..... 11
  - 6.6 Changing your tracker's password ..... 11
  - 6.7 Authorization..... 11
  - 6.8 Easy SMS Text Message Locating ..... 13
  - 6.9 Interval Tracking ..... 14
    - 6.9.1 Continuous Interval Tracking..... 14
    - 6.9.3 Smart Interval Tracking ..... 14
    - 6.9.4 How to Cancel Interval Tracking..... 14
  - 6.10 Automatic Position Updating With Movement Angle..... 15
  - 6.11 GPS drift suppression ..... 15
  - 6.12 Exact street address by SMS..... 16
  - 6.13 Location Based Service (LBS) ..... 16
  - 6.14 Voice surveillance..... 16
  - 6.15 Data Logging ..... 17
  - 6.16 Data upload ..... 18
  - 6.17 Forwarding Received SMS Messages ..... 18
  - 6.18 SIM Card Balance Check ..... 19
  - 6.19 Alarms..... 19
    - 6.19.1 Low Battery Alarm..... 19
    - 6.19.2 Power Off Alarm ..... 19
    - 6.19.3 SOS Alarm ..... 19
    - 6.19.4 Geo-fence ..... 19
    - 6.19.5 Multi-area Management ..... 20
    - 6.19.6 Movement Alarm ..... 21
    - 6.19.7 Overspeed Alarm..... 22

6.19.8 ACC/Ignition Alarm .....	22
6.20 Remote Immobilizing .....	23
6.20.1 Resume the Fuel and Power System .....	23
6.21 Arm .....	23
6.21.1 Setup Arm by SMS .....	23
6.21.2 Setup Arm by Remote Controller (RS+ model only) .....	23
6.22 Disarm .....	24
6.22.1 Disarm by SMS .....	24
6.22.2 Disarm by Remote Controller (RS+ model only) .....	24
6.22.3 Function of Remote Controller (RS+ model only) .....	24
6.24 Alarms Under Arm State .....	25
6.24.1 Door Alarm .....	25
6.24.2 Shock Sensor Alarm (default with RS+, optional with RS model) .....	25
6.24.3 ACC Alarm .....	25
6.25 Silent Mode .....	26
6.25.1 Setup Silent Mode by SMS .....	26
6.25.2 Activate Silent Mode Using Remote Controller (RS+ model only) .....	26
6.26 GSM Network Blind Spot Alarm .....	26
6.27 Status Enquiry .....	27
6.28 Hardware reset .....	27
6.28.1 SMS Reset .....	27
6.28.2 Using Reset Button .....	27
6.29 IMEI Number Request .....	27
6.30 Time Setting .....	28
6.31 TCP/UDP switch .....	28
6.32 GPRS Setting .....	28
6.32.1 APN Setting .....	29
6.32.2 APN User Name and Password Setup .....	29
6.32.3 Server IP and Port Setup .....	29
6.33 GPRS Economy Mode .....	30
6.34. Modes Switch Between "SMS" and "GPRS" .....	30
7. TROUBLESHOOTING .....	31

## 1. Introduction

103-RS can locate remote targets or vehicles by using Geographic Positioning System (GPS). 103 RS can be used as an SMS based tracker or as a real-time GPS Tracker on our GPS tracking platform – GPSTLive. It is an ideal security and information solution for your vehicle as it is able to send real-time alerts and position information or even immobilize your vehicle remotely in seconds. 103-RS is an entry-level GPS tracking device yet it features a list of useful functions such as; ignition alarm, door alarm, remote fuel cut off, geo-fence zones, 15 to 60 seconds location update intervals and previous routes taken for up to 90 days.

### Features

- 12v - 24v power support.
- Supports SMS/GPRS/Internet Network data transmission.
- External GSM and GPS antennas.
- Remote voice surveillance through the external microphone.
- SMS location reports via google maps support.
- 600 mAh backup battery.
- Remote immobilizing via fuel or power cut-off.

## 2. Applications

- Vehicle rental, Fleet Management
- Car and Motorbike tracking
- Professional vehicle tracking
- Vehicle security

### 3. Hardware Description

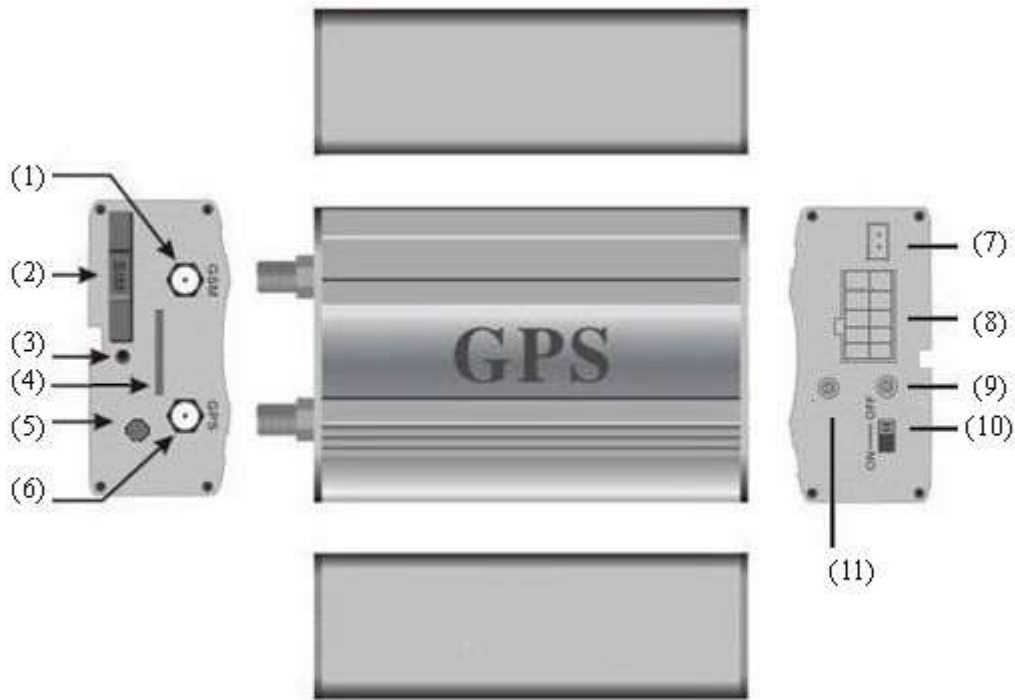

1- GSM Antenna connector

2- SIM card slot

3- SIM card slot Pop-up switch

4- MicroSD slot

5- Microphone jack

6- GPS Antenna connector

7- Shock sensor port

8- Harness Port

9- GSM/GPS LED

10- Backup battery switch

11- Remote controller antenna

(Remote Controller: RS+ model only)

## 4. Accessories

NO.	PICTURE	NAME	NOTE
1		GPS Antenna	3 meters
2		GSM Antenna	3 meters
3		Microphone	1.5 meters
4		Harness	10 PIN
5		Relay	12V/40A (24V/40A upon request)
6		Shock sensor	Optional for both RS and RS+ models
7		Siren	RS+ MODEL ONLY
8		Remote controller	RS+ MODEL ONLY

## 5. Specifications

<b>Content</b>	<b>Specifications</b>
<b>DIM.</b>	<b>83*54*26mm</b>
<b>Weight</b>	<b>120g</b>
<b>Network</b>	<b>GSM/GPRS</b>
<b>Band</b>	<b>850/900/1800/1900Mhz</b>
<b>GPS Module</b>	<b>SIRF3 chip</b>
<b>GPS Sensitivity</b>	<b>-159dBm</b>
<b>GPS Accuracy</b>	<b>5m</b>
<b>GPS Start time</b>	<b>Cold start 45s Warm start 35s Hot start 1s</b>
<b>Voltage of car power system</b>	<b>12 V -24V</b>
<b>Backup battery</b>	<b>Chargeable 3.7V 600mAh Li-ion battery</b>
<b>Storage Temp.</b>	<b>-40°C to +85°C</b>
<b>Operation Temp.</b>	<b>-20°C to +65°C</b>
<b>Humidity</b>	<b>5%--95% non-condensing</b>

## 6. Operating Instructions

### 6.1 Installation

Please ensure the installation is performed by a qualified and experienced technician. Rewire Security does not accept liability for any damages caused due to incorrect installation of the tracker.

On first installation, do not place your device in its final position. Start with just setting up your device by installing the sim card, connecting GPS & GSM antennas and leaving it in a location with an uninterrupted view of the sky. Once your 103-RS is switched on and ready to use, test the functions you would like to use and finally install it in its final position.

Do not install this device in places where it is likely to be exposed to excessive heat, water or dust.

Find the 10 PIN harness and insert it into the corresponding holes. Connect the wires with the original car circuit as shown below:

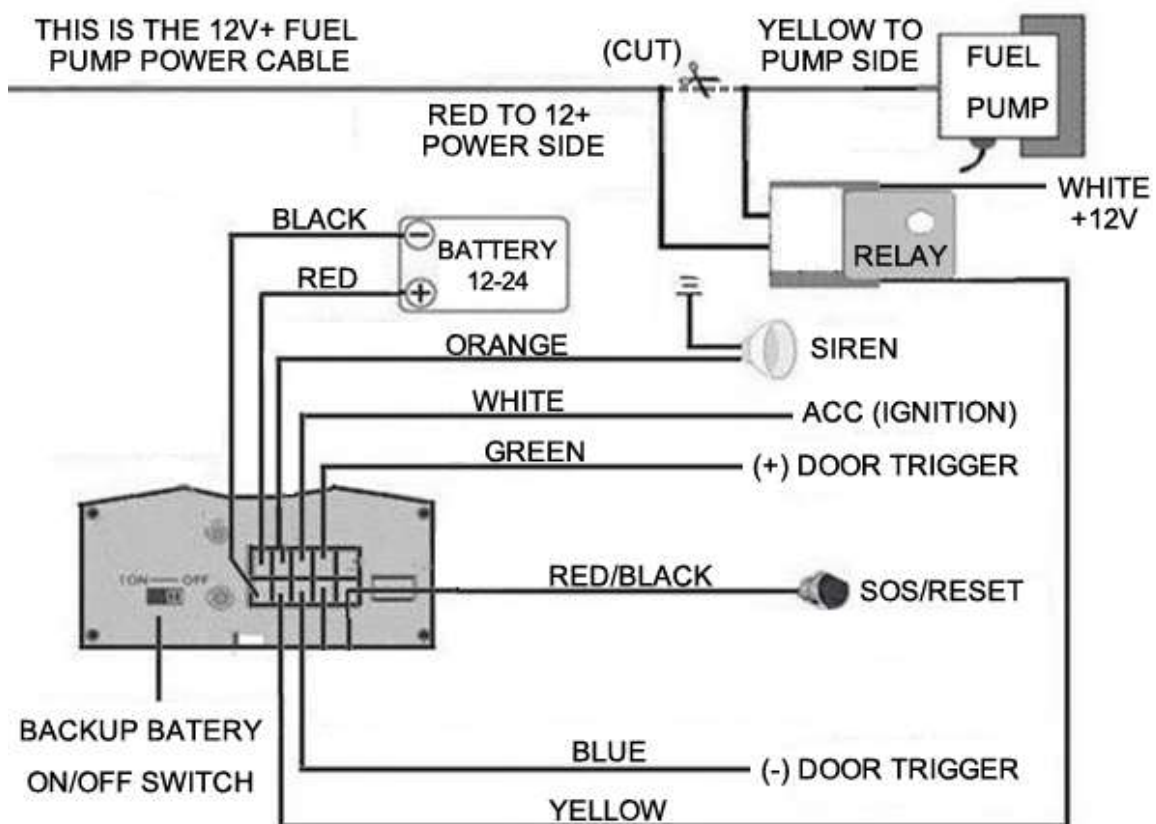

**-Wiring Diagram-**



The white cable with the black line is for the ultrasonic fuel sensor and can be discarded. User manual and installation guide for the ultrasonic fuel sensor are supplied separately upon purchase.

**Note:** The orange wire should be connected to the siren (optional), however, it can also be connected to your vehicle's horn.

Check if the type of your vehicle's door trigger is a positive or negative trigger. Please connect the green wire to the door control circuit if it is positive, and connect the blue wire if it is negative.

If you wish to use the reset and SOS button, install it where the driver can easily reach.

Insert the shock sensor plug (RS+ model, optional) into the sensor jack

Insert the external Microphone into the microphone jack and place the microphone to your desired location.

Connect the GPS and GSM antenna to the corresponding connector. Find an appropriate place and fix the antennas. Under the front dashboard is the most ideal location to fit the antennas. Thick metal surfaces (e.g. bonnet) will degrade the GPS signal and reduce accuracy. Therefore, antennas should be installed under or as close as possible to windows, windscreen or plastic surfaces.

If you wish to use the remote immobilizing function, the circuit breaker relay unit must be installed on the cable that provides +12v power to your fuel pump. Please do this by cutting the 12+ fuel pump wire and installing the relay unit in between. The thick red wire should be connected to 12+ power side (usually coming from the fuse box) and the thick yellow wire should be connected to the fuel pump side. This way the power circuit to your fuel pump will be completed through the circuit breaker relay unit. The thin yellow wire that goes to the relay unit from your tracker is the relay control switch. The thin white cable on the relay unit must be connected to 12+ to power the relay unit.

- Please note that you can also use the relay to cut off the starter motor instead of the fuel pump.

## 6.2 SIM CARD Installation

Use tweezers or a screwdriver to push the SIM CARD ejector switch, the SIM CARD slot will pop up. Remove the sim card tray and install your sim card. Now you can install the sim card tray back to its position.

Ensure that your SIM card has been activated and the PIN code request is disabled. If you are using a contract sim card and would like to use GPRS (live) tracking, make sure your SIM card's internet is enabled.

- **Please make sure that caller id display is enabled on your phone as 103-RS will not be able to respond to messages or calls from private numbers.**

## 6.3 Turn On the 103-RS

Connect the positive(red) and negative (black) wire to 12v or 24v power source, wait for 1 minute after connecting power to make sure 103-RS is operating normal, then turn on the backup battery switch.

## 6.4 GSM/GPS LED Indicator

**Red LED indicator on:** No GSM network signal.

**Fast flashing Red LED :** GSM Network signal is good and 103-RS is working in GSM mode

**Slow flashing Red LED :** GSM Network signal is good and the 103-RS is working in GPRS mode.

**Green LED indicator on:** GPS fix is established.

**Green LED indicator off:** GPS module is searching for satellite signal.

## 6.5 Initialization

**Note:** When reading this manual, you will notice that we have used "+" and "space" between some words; "+" between two words means they should be written together as one word and "space" between two words means you should leave one character space between two words. Commands are written in this format to avoid errors as some commands may consist of few words written as one word or separated by a space.

**e.g.** sleep+123456+space+shock

This command should be sent to 103-RS as following: sleep123456 shock

## 6.6 Changing your tracker's password

Send SMS "password+old password+space+new password" to 103-RS to change the password. e.g password123456 888888 . 103-RS will reply: "password OK".

-If you forget your password, you can restore it to the default password using the command: adminpassword13142324

- Please note that you only need to change your password if you intend to share your 103-RS's phone number with third parties and do not wish to give them access to its settings.

**Example :** password123456 99999

**Response:** password OK

## 6.7 Authorization

You have to add your phone number as the authorized number if you wish to receive any alerts or scheduled reports. If you only wish to use this device for tracking via SMS or GPRS, you can skip the authorization process.

**Authorization can be done in two different ways:**

**1-** Dial 103-RS's phone number 10 times from your mobile phone and it will register your mobile phone number as the authorized number automatically.

- Please note that each time you dial it, the 103-RS will hang your call after 2 seconds and reply with a location SMS message.

2- Send SMS “admin+password+space+phone number” to set up an authorized number. All the other authorized numbers must be set by the first authorized number. You will receive “admin OK” reply once the command has been executed.

**Example:** admin123456 0777666554

**Response:** admin OK

Depending on make/model of your phone, you may after switching the ignition off need to authorize your phone number with the country code. If you notice you do not get any alarms or text reports after calling your tracker, please authorize your phone number including the country code as shown below ;

**Example:** admin123456 +447776665544

**Response:** admin OK

- Please note that when entering in international format, the first 0 of your phone number should be dropped. So 07776665544 should be entered as +447776665544 in international format.

Once a number is authorized, 103-RS will only respond to SMS single locating phone calls from the authorized number. However, it will still respond to commands sent from any phone number as long as the correct password is entered. If you notice that 103-RS is not responding back with an SMS after you call its phone number, this is very likely to be caused by an error in authorization. When that's the case, you can revert 103-RS to factory defaults by sending begin123456 command or check the command you have sent for authorization and retry it again with the correct format.

**Delete authorization:** Send SMS “noadmin+password+space+authorized number” to delete the authorized number.

**Example:** noadmin123456 +447776665544

**Response:** noadmin ok

## 6.8 Easy SMS Text Message Locating

If there aren't any authorized numbers set-up, 103-RS will reply to all calls with a location report. If there are authorized numbers set-up, only authorized numbers will be able to receive location reports from 103-RS.

The SMS text message will include coordinates, current speed, time and date. It will also contain a direct Google Map link for smartphone users.

Once you click on the link, it will instantly open up Google Map for you to see the location of your vehicle.

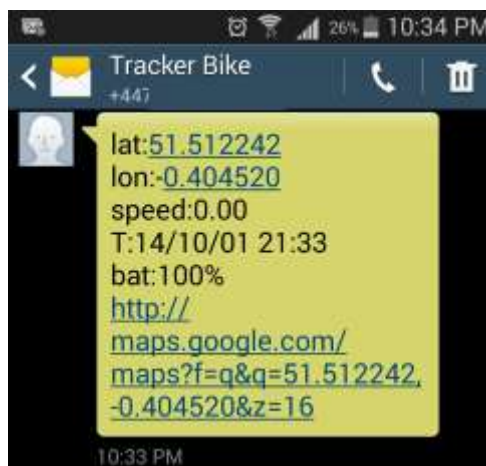

If you request your 103-RS's location when it does not have sufficient GPS signal, it will respond with a text message but will not contain any coordinates. Once it acquires enough GPS signal it will send another text message with its latest coordinates.

If the SMS position you have received from your 103-RS starts with "last", this means it does not have a current GPS fix and the position you have received is from the last location where it had a GPS fix.

## 6.9 Interval Tracking

103-RS can send automatic location reports at preset intervals. If SMS mode is active, reports will be sent as SMS text messages. If GPRS tracking mode is active, location report updates will be uploaded to the online tracking server.

### 6.9.1 Continuous Interval Tracking

Send SMS "fix030s\*\*\*n+password" to the 103-RS, it will reply the latitude & longitude continuously at 30 seconds fixed intervals.

**Note:** Minimum interval setting is 10s.

**Example:** fix030s\*\*\*n123456

- Please note that you will not get a response for this message.

### 6.9.3 Smart Interval Tracking

- Please set "Continuous interval tracking" before selecting this function.

Send "distance+password+space+distance". 103-RS will reply "Distance ok" and it will start uploading its location at preselected time intervals and distance.

**Example:** distance123456 0050

**Response:** distance OK

This means that distance is 50 meters; the number must be 4 digits. This will configure the 103-RS to send its location every 50 meters.

**To set this function on the web server:** Set time interval first and then distance interval, 103-RS will locate upon time and distance.

### 6.9.4 How to Cancel Interval Tracking

Send SMS "nofix+password" to 103-RS to cancel the interval tracking.

**Example:** nofix123456

## 6.10 Automatic Position Updating With Movement Angle

103-RS will update the positions automatically to the web server once the vehicle changes driving direction over preset angle value to form a smooth trajectory consistent with the actual road. This function is only effective in GPRS mode.

Send "angle+password+space+angle" to 103-RS, it will reply " angle ok".

The angle must be 3 digits, default angle value is 30 degrees.

**Example:** angle123456 045

**Response:** angle ok

## 6.11 GPS drift suppression

GPS signal can be effected by many factors like weather and location. Surrounding buildings or trees can reduce GPS signal strength. Clouds also degrade the signal and the locating accuracy may drop, causing your 103-RS to show up in different locations in a 50 meter radius time to time. If you are using live (GPRS) tracking you may notice your 103-RS doing 20-50meter jumps on your map when the vehicle is actually stationary. GPS drift suppression is used to avoid this. When activated, 103-RS will stop sending GPRS data to live tracking server when the ignition is OFF. GPRS drift suppression also helps with sim card economy as the GPRS mobile data will only be used while the vehicle is moving.

This function is switched "OFF" by default. Send "suppress+password" to 103-RS to activate, it will reply " suppress drift ok". The GPS data will stop updating if the vehicle is stationary. GPS data will update automatically once the vehicle starts moving. Please note that the ACC (ignition) detection wire (white) on your tracker should be connected for this function to work.

**Example:** suppress123456

**Response:** suppress ok

**To cancel:** send "nosuppress+password" to 103-RS.

**Example:** nosuppress123456

## 6.12 Exact street address by SMS

You must set the APN of your GSM network provider for the SIM card used in 103-RS before using this function. If your local GSM network requires username and password for GPRS, please set it up according to the GPRS instructions in chapter VII. Send SMS "address+password" to 103-RS after APN has been set up and it will reply with exact address including street name.

**Example:** address123456

**Response:** 20a Park street, clifton, bristol, bs1 5ja

## 6.13 Location Based Service (LBS)

If 103-RS is unable to establish a solid GPS fix, it will calculate its location using the Cell-id info. Location reports will include the GPS coordinates of the last known position as well as a LAC code. Entering the LAC code to the "Manual Track" menu of your web tracking platform will enable you to see 103-RS's current location.

You can also send command "address+password" to 103-RS to request exact address. 103-RS will automatically switch to tracking by LBS in GPRS mode. The accuracy of LBS (also known as Cell-id tracking) depends on the distance to the nearest GSM Network Cell Tower or Base Station. In urban areas, this accuracy varies between 25-100 meters.

## 6.14 Voice surveillance

103-RS is in Tracking mode by default. When voice surveillance mode is activated, it will automatically answer incoming calls rather than replying with its location information.

To activate the monitor mode, send SMS "monitor+password" to 103-RS. It will reply "monitor ok" and switch to "monitor" mode.

**Example:** monitor123456

**Response:** monitor OK



Do not forget to switch back to tracker mode once you have finished using the voice surveillance. When 103-RS is in monitor mode it will stop updating its position and it will shut the GPS module "OFF". To change back to tracker mode use command "tracker+password"

**Example:** tracker123456

**Response:** tracker OK

## 6.15 Data Logging

**Auto logging:** If 103-RS loses GSM or GPRS signal, it can store the tracking position and alerts automatically on to the flash drive upon the pre-set conditions. When GSM signal is acquired, all the event alerts will be auto-sent to authorized numbers and the live tracking server.

Logging at preset intervals: Send SMS: "save030s005n+password" to 103-RS, it will reply "save ok", and will log the lat, long locations every 30 seconds for 5 times. (S: second, m: minute; h: hour).

**Example:** save030s005n123456

**Response:** save ok

**Continuous logging:** Send SMS:"save030s\*\*\*n+password" to 103-RS, it will reply "save ok".

**Example:** save030s\*\*\*n123456

**Response:** save ok

**Logging Clearance:** Send SMS: "clear+password" to 103-RS, it will reply "clear ok".

**Example:** clear123456

**Response:** clear ok

**Logging Volume:** Built-in flash 1MB (store about 16,000 positions). This volume can be expanded by using a Micro SD card which can be inserted into the provided slot. Please refer to section 3.3 to see where micro SD card needs to be inserted.

- A 2GB card would be sufficient for up to 10 months.

Data logging function also enables you to use your 103-RS as a GPS logger. You can download the location data to your PC by using the free PC software provided, through USB connection.

## 6.16 Data upload

**Auto Upload:** If there is no GSM reception, 103-RS will save all GPS data to its built-in memory and upload this information to the live tracking server automatically when the GSM reception is back to normal. This way tracking data won't get lost while driving through areas with no or low GSM reception. If you do not wish to use this feature, you can turn it "OFF" by sending the SMS command "autoload+password+space+off"

**Example:** autoload123456 off

**Response:** autoload off OK

**Specified Date Load :** Send SMS: "load+password+space+year month date" to 103-RS. It will reply: "load ok" and will upload the tracking data of the specified time/date.

**Example:** load123456 20110425

**Response:** load ok

## 6.17 Forwarding Received SMS Messages

103-RS can forward incoming messages from pre-set phone numbers. To activate this function, send "forward+password+space+third party phone number" from an authorised phone number. 103-RS will reply "forward ok", and start forwarding SMS messages coming from that number. Only one number can be set-up for SMS forwarding.

**Example:** forward123456 07776665544

**Response:** forward ok

To cancel SMS forwarding send SMS command "noforward+password".

**Example:** noforward123456

**Response:** no forward ok

## 6.18 SIM Card Balance Check

Send SMS command "balance+password+space+carrier's phone number+space+code" to the tracker, it will forward the content to the specified phone number and return the content from the specified phone number.

**Example:** balance123456 0262 check

**Note:** This function assumes that the GSM Network provider has the option where you can check your Sim Card's balance by sending a command to a specific number; which is 0262 in this example.

## 6.19 Alarms

### 6.19.1 Low Battery Alarm

When the voltage of the 103-RS is near 3.6V, it will send SMS "low battery+lat./long" information to authorized numbers twice in 3 minutes intervals.

### 6.19.2 Power Off Alarm

When the external power to 103-RS is cut off or at 0V, 103-RS will send SMS "power alarm+lat./long." to authorized numbers twice in 3 minutes intervals.

### 6.19.3 SOS Alarm

Press and hold the SOS button for 3 seconds and the 103-RS will send 3 SMS reports to all authorized numbers.

### 6.19.4 Geo-fence

This function allows you to create safety zones of your choice. When 103-RS enters or leaves this pre-determined zone, it will send geo-fence alarm warning to authorized numbers.

When 103-RS stays immobile in a place for 3-10 minutes, you can send SMS "stockade+password+space+latitude,longitude;latitude,longitude" to 103-RS to set the zone. In case of a breach, it will send SMS "stockade!+location" to

authorized numbers every 3 minutes. It will stop sending alarm once it returns back to the zone.

**Note:** The first latitude & longitude is coordinate of the top left corner of the Geo-fence, while the second latitude & longitude is the coordinate of the bottom right corner.

**Example:** stockade123456 51.460959, -2.622643; 51.456842, -2.604446

You can obtain coordinates of any location from Google Maps by clicking on the desired location and selecting "what's here?"

**To Cancel:** Send SMS "nostockade+password" to deactivate this function.

If you are using live tracking on our server [www.gpslive.co.uk](http://www.gpslive.co.uk), geo-fence zones can also be created online.

**Example:** nostockade123456

#### 6.19.5 Multi-area Management

**To set an area for multi-management:** Send SMS command "area+password+space+latitude,longitude+space+areaname,distanceM" to 103-RS(distance unit: M for meter, K for kilometer). 103-RS will reply "area01ok".

**Example:** area123456 22.353648,113.543678 school,800M

**Response:** area ok

**Note:** 5 areas at most and the distance between two points can't be less than the total distance in the 2 commands. Different areas can't cover each other.

**Delete areas:** Send SMS command:"noarea+password+space+area name", 103-RS will reply:"noarea ok".

**Example:** noarea123456 school

**Response:** noarea ok

**Rename and set distance:** Send SMS command "rename+password+space+old name;new name,distanceM" to 103-RS. If name is not repeated and area doesn't cover other areas, it will reply "rename ok!" if the configuration was successful.

**Example:** rename123456 area01;school,800M

The new area name will be "school", and will cover an area of a radius of 800 meters.

**Activate multi-area management:** Send SMS command "area+password+space+on" to 103-RS and it will reply "Area on ok!". When 103-RS enters the preset area, it will send SMS "area location" to all authorized phone numbers, and it will send the same SMS when goes out of the area.

**Example:** area123456 on

**Response:** area on ok

**Deactivate Multi-area management:** Send SMS command "area+password+space+off" to 103-RS, it will reply "area off ok!"

**Example:** area123456 off

**Response:** area off ok

#### 6.19.6 Movement Alarm

**Setup:** When 103-RS stays immobile in a place for 3-10 minutes with GPS signal reception you can send SMS "move+password+space+0200" to 103-RS. This will activate the movement alert with an area radius of 200 meters. Maximum radius limit is 999 meters. 103-RS will reply "move OK". In case of such a movement, it will reply SMS "move+location" to authorized numbers at 3 minutes intervals.

**Example:** move123456 0250

**Response:** move ok

**Note:** Setting the radius less than 100 meters may result in false movement alert. The fault alert occurs if GPS position is miscalculated due to bad GPS reception. Inaccurate GPS reading will cause the 103-RS to think that it is in a different location, possibly further from its current location, thus the processor will accept this as a movement and trigger the movement alarm. However, this may only occur if the 103-RS is installed improperly in a place where it can't receive a good signal.

**To Cancel:** Send SMS "nomove+password" to deactivate the movement alarm.

**Example:** nomove123456

**Response:** nomove ok

### 6.19.7 Overspeed Alarm

Over speed alarm will be triggered when 103-RS exceeds speed limit predetermined by you.

**Setup:** Send SMS “speed+password+space+speed” to 103-RS and it will reply “speed ok!”. This means that you have set up over speed alarm successfully.

**Example:** speed123456 080

080 refers to 80km/h. When your vehicle's speed exceeds 80km/h, 103-RS will send SMS “speed+080!+ location” to authorized numbers.

**To Cancel:** Send SMS “nospeed+password” to deactivate the over speed alarm.

**Note:** Recommended minimum setting for over speed alarm is 30km/s.

**Example:** nospeed123456

**Response:** nospeed ok

### 6.19.8 ACC/Ignition Alarm

This function is switched "OFF" by default. To activate, send "ACC+password" to 103-RS, it will reply "ACC ok" and send "ACC on+latitude & longitude" to authorized numbers when the ignition of the vehicle has been switched "ON"; and it will send “ACC off+latitude & longitude" to authorized numbers, which means the ignition of the vehicle is "OFF".

**Example:** acc123456

**Response:** acc ok

Send SMS command "noACC+password" to disable this function.

**Example:** noacc123456

## 6.20 Remote Immobilizing

Send command “stop+password” to 103-RS. Once the immobilize function has been executed, it will reply “Stop engine Succeed”. It will remain immobile until you send a command to resume the fuel supply. Before using the stop command, please select execute immediately mode or normal mode;

**Example:** stop123456

**Response:** Stop engine succeed

### 6.20.1 Resume the Fuel and Power System

Send “resume+password” to 103-RS, it will reply "Resume engine succeed", this means the 103-RS will now resume the fuel & power supply.

**Example:** resume123456

**Response:** Resume engine succeed

## 6.21 Arm

### 6.21.1 Setup Arm by SMS

Send SMS command “arm+password” to your 103-RS. It will reply “Tracker is activated” and it will enter armed state if it is currently disarmed.

You will only be able to "arm" your 103-RS's alarm if the ignition is "OFF" and the doors are closed. If not, you will receive the following response from 103-RS: “set up fail! please turn off ACC”

**Example:** arm123456

**Response:** tracker is activated

### 6.21.2 Setup Arm by Remote Controller (RS+ model only)

Press button on the remote controller, the 103-RS will enter the armed state and the siren will beep once.

## 6.22 Disarm

### 6.22.1 Disarm by SMS

Send SMS command "disarm + password" to your 103-RS, It will reply "Tracker is deactivated" 103-RS will enter disarmed state.







**Example:** disarm123456

**Response:** tracker is deactivated

### 6.22.2 Disarm by Remote Controller (RS+ model only)

Press button on the remote controller and the 103-RS+ will enter the disarmed state. The siren will beep twice.

### 6.22.3 Function of Remote Controller (RS+ model only)

Button	Function	Descriptions
	ARM	Press for 0.5 seconds, the siren will beep one time.
	DISARM	Press for 0.5 seconds, the siren will beep two times.
	ARM & Silent mode	Press for 0.5 seconds when it is in disarm state, the siren will beep three times. In silent mode, the siren will not work even if an alarm is triggered.
	SOS	Press for 3 seconds, 103-RS will send SOS alert to authorized phone numbers.
	Deterrence/carr locate	Press for 0.5 seconds when it is in arm state, the siren will beep 10 seconds, press disarm button  to stop.



## 6.24 Alarms Under Arm State

### 6.24.1 Door Alarm

103-RS will send SMS “Door alarm+lat/long” to authorized numbers in 3 minutes intervals when a door has been opened; Siren will sound for 30 seconds, and circle again with 20 seconds intervals. Send SMS command “disarm+password” to stop.

**Example:** disarm123456

### 6.24.2 Shock Sensor Alarm (default with RS+, optional with RS model)

103-RS will send SMS “Sensor alarm+lat/long” to authorized numbers in 3 minutes intervals when the sensor is triggered in arm status; Siren will sound for 5 seconds. Send SMS command “disarm+password” to stop.

**Example:** disarm123456

### 6.24.3 ACC Alarm

103-RS will send SMS “ACC alarm+lat/long” to authorized numbers in 3 minutes intervals when the ignition is switched on, Siren will sound for 30 seconds, and circle again with 20 seconds intervals. Send SMS command “disarm+password” to stop.

**Example:** disarm123456

## 6.25 Silent Mode

### 6.25.1 Setup Silent Mode by SMS

Send SMS “silent+password” to 103-RS, it will reply “silent ok!”.103-RS will enter silent mode, the siren will be deactivated but it will still send SMS alerts to authorized numbers.

**Example:** silent123456

**Response:** silent ok!

Quit silent mode send SMS “loud+password” to the 103-RS, it will reply “loud ok!”.

**Example:** loud123456

### 6.25.2 Activate Silent Mode Using Remote Controller (RS+ model only)

**Silent mode:** Press for 0.5 seconds when it is in disarm state, the siren will beep three times. In silent mode, the siren will not work even if an alarm is triggered.

**Quit silent mode:** Press in disarm state for 0.5 seconds again, the siren will beep two times, and quit from silent mode.

## 6.26 GSM Network Blind Spot Alarm

If 103-RS has no GSM reception, the siren will still work if an alarm is triggered (door, sensor, ACC), however, SMS alarm reports will only be sent when the GSM reception is back to normal.

## 6.27 Status Enquiry

Send SMS command “check+password” to the 103-RS in the vehicle, It will reply with the status of the power, battery, GPS, ACC, door, GSM signal, fuel level, APN, server IP address and port to authorized numbers.

**Power:** ON/OFF

**Battery:** 100%

**GPRS:** ON/OFF

**GPS:** OK/NO GPS

**ACC:** OFF/ON

**Door:** OFF/ON

**GSM Signal:** 1-32

**Oil:** 0.00% (fuel level, requires optional ultrasonic fuel sensor)

**APN:** data.lycamobile.co.uk

**IP:** [listener.gpslive.co.uk](http://listener.gpslive.co.uk) PORT: 10200

## 6.28 Hardware reset

### 6.28.1 SMS Reset

Send SMS “reset+password” to 103-RS to reset the GSM module and GPS module, it will reply “reset ok”.

**Example:** reset123456

**Response:** reset ok

### 6.28.2 Using Reset Button

Press the reset button for 1 second, the hardware of 103-RS will reset.

## 6.29 IMEI Number Request

Send SMS command "imei+password" to 103-RS. E.g. Send SMS command "imei123456" to 103-RS and it will reply with its 15 digit IMEI number.

**Example:** imei123456

**Response:** 359710055647863

### 6.30 Time Setting

Send SMS command "time+space+zone+password+space+time" to 103-RS, It will reply "time OK".

**Example:** time zone123456 0 (0 is GMT 0 UK time zone)

**Response:** time ok

If your country time zone is minus, send the time zone with a "-" symbol.

**Example:** time zone123456 -2

**Response:** time ok

### 6.31 TCP/UDP switch

**Command:**"gprs+password,1,1" switch to UDP mode.

**Command:** "gprs+password,0,0" switch back to TCP mode, this is the default mode. If you would like to use our own server [www.gpslive.co.uk](http://www.gpslive.co.uk), you do not have to change this setting.

### 6.32 GPRS Setting

GPRS tracking mode allows 103-RS to upload its location data to a web server at preset intervals.

APN, Update intervals and server's IP address must be configured to be able to use GPRS (live internet) tracking.

### 6.32.1 APN Setting

APN stands for Access Point Name and differs with each GSM network. For more information, contact your local SIM card network operator. Send SMS “APN+password+space+APN”, 103-RS will reply “APN OK” if succeeded.

**Example:** apn123456 orangeinternet

**Response:** apn ok

**Note:** orangeinternet is the APN code for pay as you go services of Orange GSM network. the APN varies with different GSM network operators in different countries, please check with your local GPRS network operator to get the correct APN. See examples below for some UK networks.

**apn123456 data.lycamobile.co.uk** -> Lyca mobile UK

**apn123456 uk.lebara.mobi** -> Lebara UK

**apn123456 everywhere** -> ee pay as you go

### 6.32.2 APN User Name and Password Setup

Most networks do not require password authentication while setting up the APN. However, if your network requires this setting please configure as following:

Send SMS “up+password+space+user+space+password”, If succeeded, 103-RS will reply “user, password ok!”.

**Example:** up123456 data user

**Note:** 123456 is the password for 103-RS, data is the username for GPRS login, the user is the password for GPRS login.

### 6.32.3 Server IP and Port Setup

This setting will configure the 103-RS to upload its location to the selected live tracking server.

Send SMS "adminip+password+space+IP+space+port" to 103-RS. It will reply "adminip ok" if succeeded

**Example:** adminip123456 listener.gpslive.co.uk 10200

**Response:** adminip ok

**Note:** listener.gpslive.co.uk is the IP address of default server www.gpslive.co.uk and 10200 is the port.

### 6.33 GPRS Economy Mode

With this feature after switching the vehicle ignition off 103-RS will enter GPRS economy mode and close the GPRS (mobile internet) connection.

It will automatically reconnect once the ignition is turned back ON.

**To activate this function:** Send "less gprs+password on", 103-RS will reply "less GPRS on ok".

**Example:** less gprs123456 on

**Response:** less gprs on ok

**To deactivate:** Send "less gprs+password off".

**Example:** less gprs123456 off

**Response:** less gprs off ok

- Please note that the ignition (ACC) detection wire must be connected to your vehicle's ignition for this feature to work.

### 6.34. Modes Switch Between "SMS" and "GPRS"

103-RS is in SMS mode by default.

To activate GPRS mode, send SMS "GPRS+password" to 103-RS, and it will reply "GPRS ok!"

**Example:** gprs123456

**Response:** GPRS ok!

Send SMS "SMS+password" to 103-RS, it will reply "SMS ok!" and restore to "SMS" mode.

## 7. Troubleshooting

Faults	Solution
<b>No LED light</b>	Please make sure 103-RS is wired correctly & receiving power from the 12 or 24v source
<b>No dial tone</b>	First, check the LED lights on 103-RS. If 103-RS is Receiving power, no dial tone means there is no GSM. <b>1-</b> Check if the sim card you are using is active. <b>2-</b> Ensure the GSM & GPS antennas are installed the right way around. <b>3-</b> Test the sim card on a mobile phone and see if the network you are using does not have any reception issues in your area.
<b>No response to Text commands</b>	First, ensure there is dial tone when you call 103-RS's SIM number. If there is a dial tone, there are two possible causes for 103-RS not to respond to your commands; <b>1-</b> There is no balance/credit on the sim card you are using. <b>2-</b> You are using a wrong password (default:123456)

<p><b>No location report SMS after calling 103-RS</b></p>	<p><b>1-</b> If there is an authorized phone number registered, 103-RS will only respond to authorized phone numbers with SMS location reports.</p> <p><b>2-</b> Ensure that you are not calling from a withheld or private phone number.</p>
<p><b>Wrong position In SMS mode</b></p>	<p><b>1-</b> Check if the position report starts with the word "Last". If so, this means that 103-RS hasn't established a GPS fix since and it is showing the last position it did have a solid GPS fix.</p> <p><b>2-</b> If the coordinates on position report are showing 0, this means that 103-RS hasn't established a GPS fix yet. Move your 103-RS to a position with clear line of sight</p>
<p><b>Wrong position In GPRS mode (internet/ live Tracking Server)</b></p>	<p><b>1-</b> If your 103-RS is showing up in the middle of the ocean just outside the gulf of guinea, it means the tracker hasn't sent any data or position coordinates to the server and it is currently on default, zero coordinate position. Please check your APN, GPRS server IP / port and interval settings. Most common reason for this issue is the APN settings. Some networks may have a few different APN settings for different sim cards or bundles. We recommending contacting your sim network provider to obtain the correct APN information.</p> <p><b>2-</b> If your 103-RS is still showing up at a previous location, this means it hasn't sent any position data to the Online tracking server since you have left that location. If this is a persistent problem, your 103-RS may not be receiving sufficient GPS signal, and that may cause delayed position update.</p>



**Thank you for purchasing 103-RS GPS Tracker. Please read this manual carefully before using this product. Please note that product specifications and information in this user guide are subject to changes without prior notice. Any changes will be integrated into the latest release. The manufacturer assumes no responsibility for any errors or omissions in this document.**

By purchasing the RS-103 you agree our terms and conditions, view Terms and Conditions here : <https://www.rewiresecurity.co.uk/terms>